



Specifications

AP 90 H-SL SERIES

Slim Fit Bathroom Fan with 8W 2700K LED Light and Integrated Humidity Sensor

Description: Slim fit bathroom fan with 13W 2700K 800 Lumens LED light • Engineered for continuous run • Integrated user adjustable humidity sensor • Ceiling mount • Suitable for new construction or remodeling • HVI certified • ETL listed for use in insulated ceilings (Type I.C.).

Motor/Blower: Permanently lubricated enclosed condenser motor engineered for continuous energy efficient operation; power rating 120v/60Hz; motor equipped with thermal shut off.

Housing: Rugged 26 GA galvanized steel; detachable 4 and 6” duct connector with built-in back draft dampener; 2 anti-vibration hangar bar brackets adjustable to 24” span included; designed for ceilings with a minimum of 6” clearance.

Grille: Contemporary design; low maintenance, wipe clean UV inhibiting polymeric resin; attaches to housing with torsion springs.

Finishes: White (W); Satin Nickel (SN); Oil Rubbed Bronze (OR).

Light: 8W 2700K 800 Lumens LED light.

User-Adjustable Integrated Sensor: Humidity sensor adjustable from 50-100% relative humidity (RH).

Installation: Must be installed by a licensed professional. Complete installation instructions included.

Warranty: 6 Years

Architect’s Specifications: Ventilation fan will be ceiling mount and no more than 0.3 sones at 90 CFM as certified by HVI at 0.1 Ps (inches water gauge). Power consumption shall be no greater than 33 watts with an efficiency rating of no less than 2.7 CFM/watt. Light shall be 8W 2700K LED light pad The motor will be permanently lubricated, engineered for continuous operation. Duct diameter will be 4” or 6” round. Fan will begin operation when humidity rises above user adjustable setpoint (50-100% RH). Fan shall be ETL/cETL listed for tub/shower enclosure when used with GFCI branch circuit wiring and shall be ETL/cETL listed for use in insulated ceiling (Type I.C.).

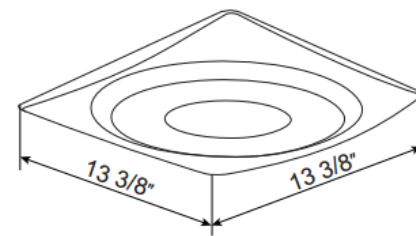
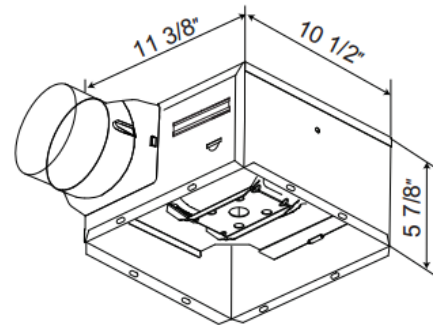

ETL Listed for installation over tub/shower enclosure with GFCI circuit wiring.



Model: AP90 H-SL Series	4” Duct	
Static Pressure (inches w.g.)	0.1	0.25
Air Volume (CFM)	90	73
Noise (sones)	0.3	n/a
Power Consumption (Watts)	33	32.3
Energy Efficiency (CFM/Watts)	2.7	2.2
Current (AMPS)	0.4	0.36
Grille Dimensions	13 3/8” x 13 3/8”	

Model	Qty	Comments	Project
			Location
			Architect
			Engineer
			Contractor
			Submitted by
			Date